

DZ series pilot-operated sequence valves are used to control the sequencing, braking, unloading or other functions. The valve has two connection types and four kinds of control methods of pilot oil, therefore, it has different functions by changing the control method of pilot oil.



Technical specification

Model	DZ-10	DZ-20	DZ-30
Max.flow rate (l/min)	100	200	400
Working pressure (MPa)	21		
Weight(kgs)	3.4	5.3	8

Ordering details

DZ	10	1	6X	210	X	M	2	V
Sort	Nominal size	Adjustment type	Series number	Pressure adjustment range	Oil control	With check valve	Drain port thread	Seals
Pilot operated sequence valve	10:NG10 20:NG20 30:NG30	1:Rotary knob 2:Sleeve with hexagon and protective cap 3:Lockable rotary knob with scale	6X6X series	210:210MPa	No code:Internal control internal drain X:External control internal drain Y:Internal control external drain XY:External control external drain	No code: Without check valve M: With check valve	No code:G1/4" 2:M14×1.5	No code: NBR seals for petroleum oils V: FPM seals for phosphate ester

Symbol list

DZ- *- M

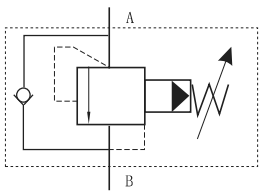

DZ- *-X-M

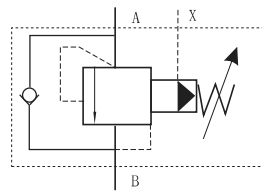

DZ- *-Y-M

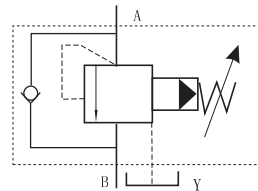

DZ- *-XY-M

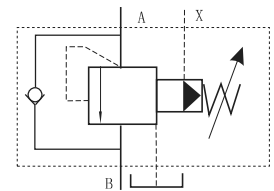

DZ- *

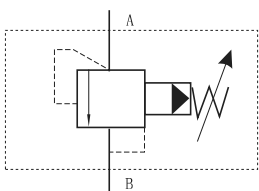

DZ- *-X

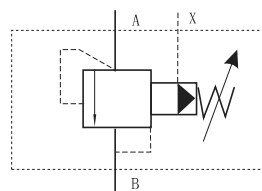

DZ- *-Y

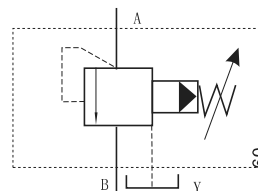

DZ- *-XY

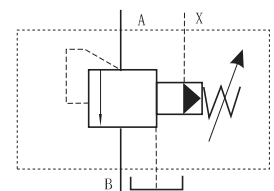

Dimensions

Unit: mm

DZ-10/20/30

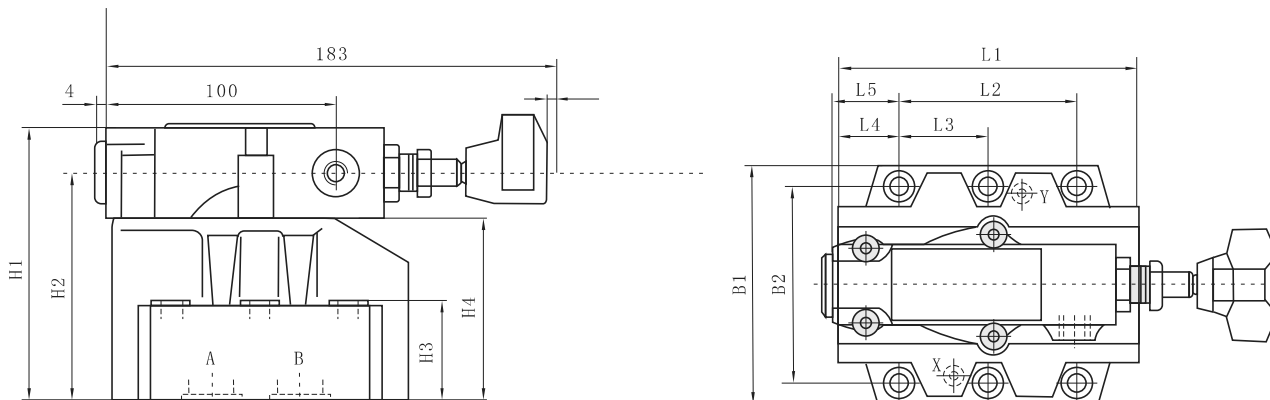

Model	B1	B2	H1	H2	H3	H4	L1	L2	L3	L4	L5	O-Ring		Fixings crew GB70-85	
												Port X, Y	Port A, B		
DZ-10	85	66.7	112	92	28	72	90	42.9	-	35.5	34.5	8.73x1.78	17.13	2.62	4-M10x50-12.9
DZ-20	102	79.4	122	102	38	82	112	60.3	-	33.5	36.5		26.58	3.53	4-M10x60-12.9
DZ-30	120	96.8	130	110	46	90	140	84.2	42.1	28	31.3		35.6x3.6	6-M10x70-12.9	

Mounting size

Unit: mm

DZ-10

DZ-20

DZ-30

