

Two-way, two-position

HLSV-06-221

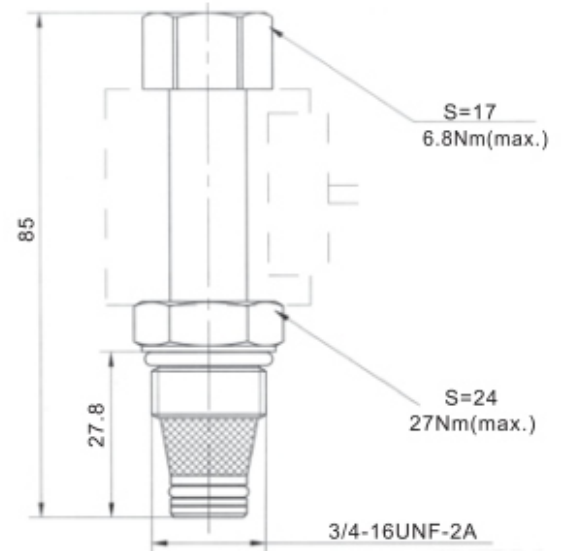

Technical specification

- Max. working pressure: 250bar
- Max. flow rate: See pressure drop-flow curve
- Internal leakage: ≤ 5 drops/min
- Voltage: 12VDC, 24VDC, 110VAC, 220VAC
- Minimum working voltage: 90% of working voltage
- Oil cleanliness: 25u m or better
- Filter net precision: 150meshes/cm²

Symbol

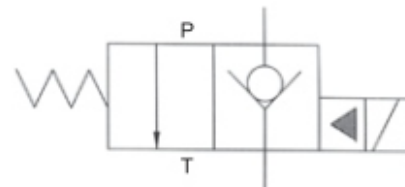

Cavity dimensions

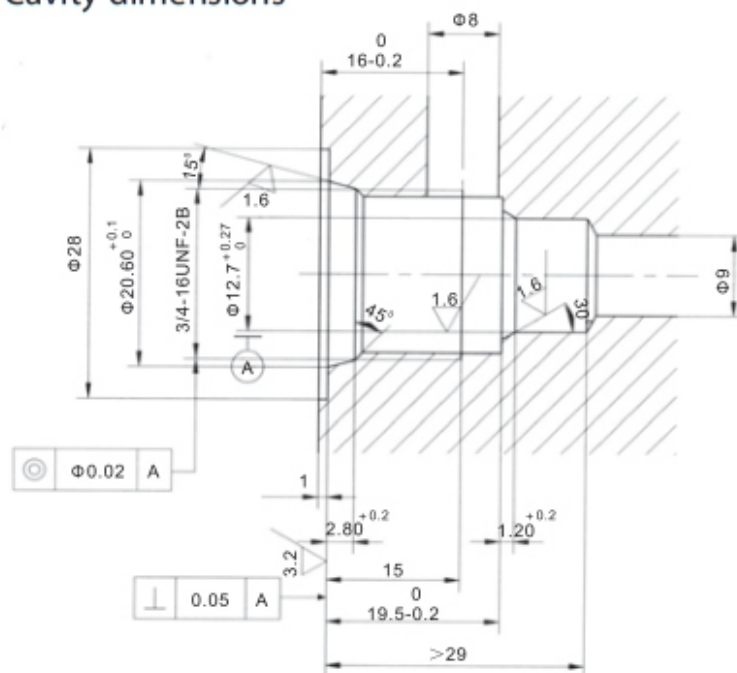

Pressure drop-flow curve
32 cST Oil/45°C
P—T ———
T—P - - -

